

/ Perfect Welding / Solar Energy / Perfect Charging



ARCROVER 15/22 WELDING CARRIAGES

for longitudinal welding seams, welding process: MIG/MAG

HORIZONTAL OR VERTICAL. BUILDING SITE OR WORKSHOPS. THE BEST SEAMS WITH ARCROVER.

Whether on the construction site or in the workshop, in bridge and steel construction, boiler, container, ship, rail vehicle or crane construction – the magnetic ArcRover 15/22 carriages lend a consistently high and reproducible quality to MIG/MAG processes.

So what's your
welding challenge?

Let's get connected.

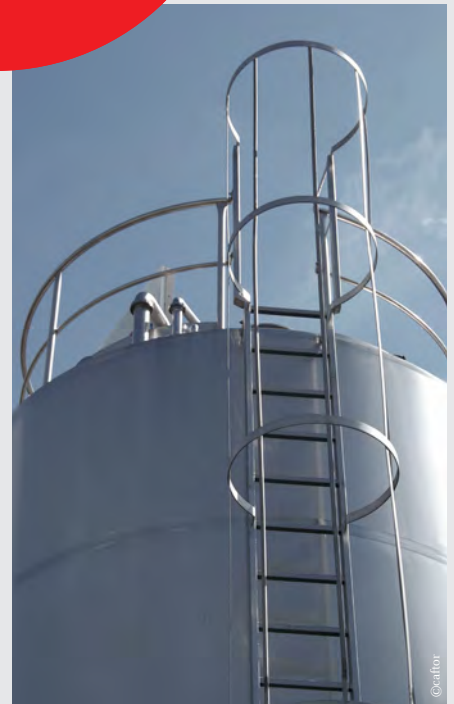

Powerful
lithium-ion
battery

Integrated
control

Four-wheel drive
and extra strong
permanent magnet





Low height
allows for
even more
applications

Fronius
power source
technology
for perfect
weld seams

ARCROVER 15

COMPACT, ROBUST AND SAFE

YOUR BENEFITS AT A GLANCE

- / Ideal for use under tough environmental conditions
- / Meets safety rules for welding the inside of containers
- / Powerful lithium-ion battery
- / Maximum traction on horizontal, vertical, concave and convex components
- / Constant welding speed in all positions up to 250 cm/min
- / Precise welding torch guidance on the component, definable welding segments
- / Consistently high welding seam quality and reproducible welding parameters combined with Fronius power source technology
- / Compact, robust and lightweight aluminium housing
- / Global service network

Constant
welding speed
in all positions

FEATURES

- / Four-wheel drive, built-in permanent magnet
- / Integrated control system with illuminated display and travel-measuring system
- / Lateral guides can be adjusted to the weld seam tracking
- / Robust universal welding torch holder for hand and machine welding torch
- / Connection cable to power source (10 m)
- / Changeable lithium-ion battery (25.4 V/3.35 Ah) and charging unit (230 V)

FUNCTIONS

- / Main switch: on/off
- / Left/stop/right
- / Speed control
- / Menu-based control system for travel paths and segment welding
- / Welding on/off (2-step mode)
- / Storage for 10 programs

OPTIONS AND ACCESSORIES

- / Lateral guides
- / Charging unit (230 V)
- / Changeable lithium-ion battery (25.4 V/3.35 Ah)
- / Stainless steel wheels
- / Brushes

ARCROVER 15. SPECIALISING IN LONG WELD SEAMS.



STANDARD EQUIPMENT

A	Control unit ON/OFF toggle switch	G	Illuminated display
B	Connection for power source control	H	Adjustable guide rails
C	CAN communication connection	I	Removable rechargeable battery pack
D	Welding toggle switch I/0/TEST	J	Handle
E	Toggle switch Start LEFT/0/RIGHT	K	Universal welding torch holder
F	Adjusting dial menu		

STANDARD LATERAL GUIDES FOR ARCROVER 15 (IN SCOPE OF DELIVERY)



LATERAL GUIDE **ON TORCH SIDE**

On inside and outside of vertical surface

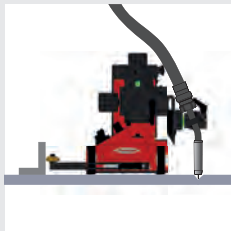

LATERAL GUIDE **OPPOSITE TO WELDING TORCH**

On the elbow piece and outside of vertical surface



OPTIONAL LATERAL GUIDES FOR ARCROVER 15



LATERAL GUIDE **TILTABLE**



LATERAL GUIDE **FOR EDGE**

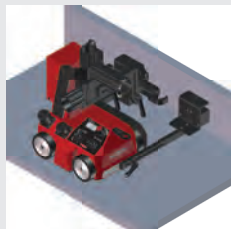

LATERAL GUIDE **STANDARD WITH MAGNET**

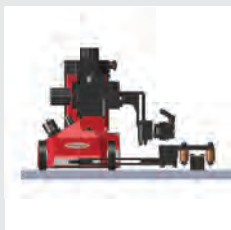

LATERAL GUIDE **WITH GUIDE RAIL**

- / Guide arm for flexible rail
- / Magnetic bases for guide rail
- / Flexible guide rail



OPTIONS/ACCESSORIES

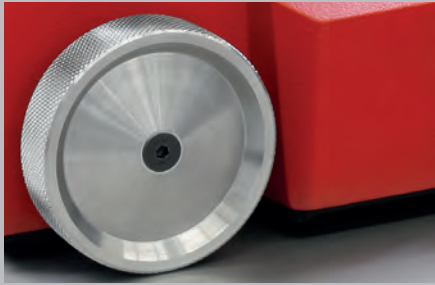

Stainless steel wheels

/ Optional. For use on preheated components from 50°C to 150°C max. It is only possible to use the carriage in the horizontal position with stainless steel wheels.



Brushes

/ Optional (assembly sketch). Ensure that the carriage can move smoothly by removing any surface dirt.



LITHIUM-ION BATTERY / CHARGER

/ High-performance 25.4 V DC lithium-ion batterie with charging unit. Minimum operating time with normal usage and no oscillation = 4 h.

APPLICATION EXAMPLES



/ Welding butt welds on horizontal components



/ Welding fillet welds on horizontal components



/ Welding butt welds on vertical components

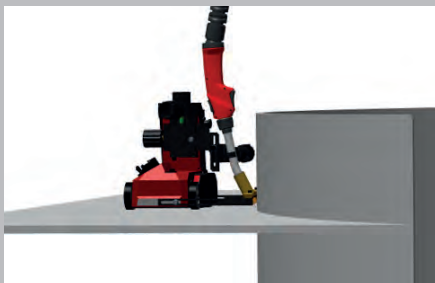

/ Welding fillet welds on convex components

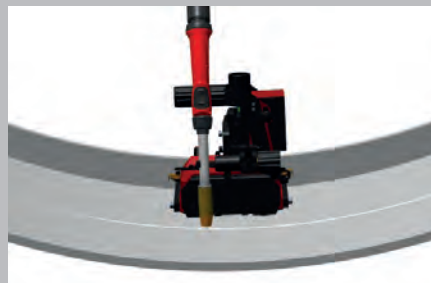

/ Welding butt welds on concave components

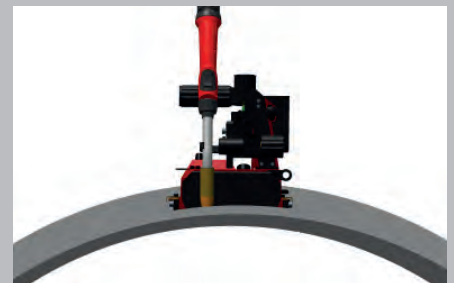

/ Welding butt welds on convex components

TECHNICAL DATA

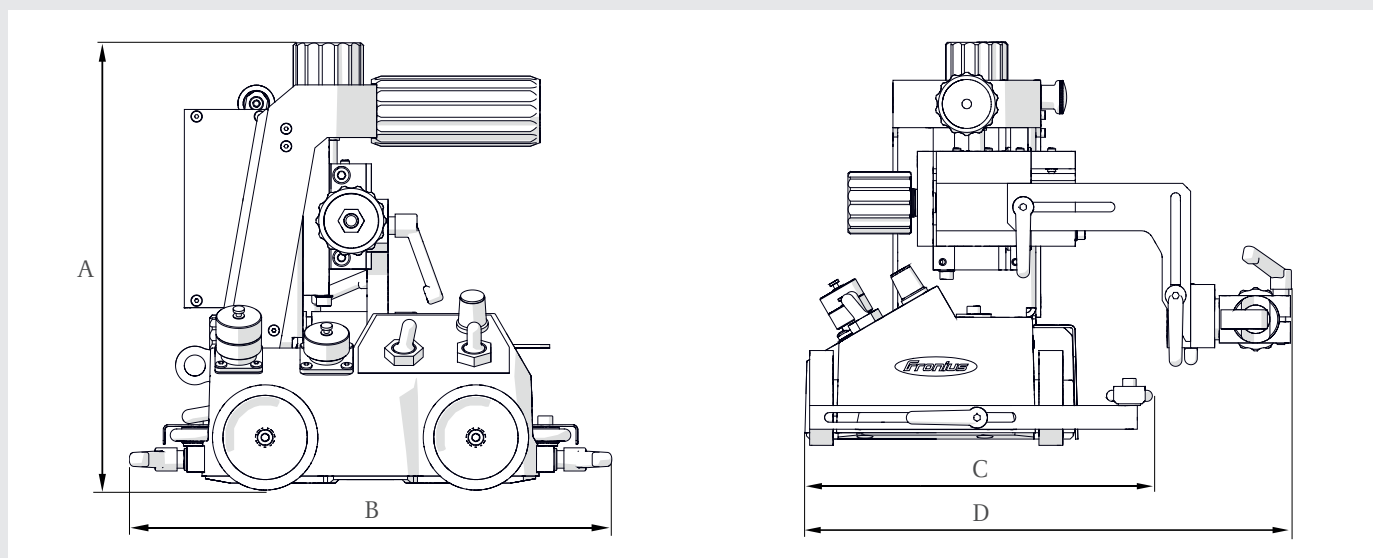

ARCROVER 15

Maximum load capacity	15 kg
Max. traction horizontal/vertical (on hosepack holder)	160 N / 110 N
Welding position horizontal/vertical	PA, PB, PC/PF, PG
Horizontal speed (load = 85 N)	5 - 250 cm/min (+/- 2%)
Vertical speed (load = 85 N)	5 - 250 cm/min (+/- 4%)
Adjustable torch travel (horizontal/vertical)	30 mm/30 mm
Welding torch neck diameter	Max. 28 mm
Battery charging unit supply voltage (50 - 60 Hz)	110 - 230 V
Carriage supply voltage (lithium ion battery)	25.4 V DC
Energy consumption	39 W
Lithium-ion battery charging time	2 h
Unladen weight including lithium-ion battery	7.1 kg
Concave seam R min.	500 mm
Convex seam R min.	500 mm
Ground clearance	4 mm
Operating time for each lithium-ion battery with normal usage	approx. 8 h
A	255 mm
B	275 mm
C	198 - 313 mm
D	253 - 335 mm

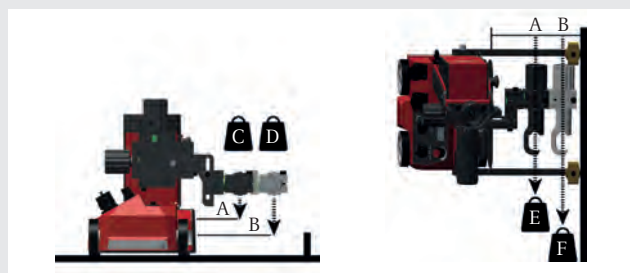

MAX. TENSILE LOAD ON THE HOSEPACK HOLDER

A	50 mm
B	80 mm
C	15 kg
D	12 kg
E	10 kg
F	8 kg



Radial torch
oscillation for fillet
and butt welds

Fronius
power source
technology
for perfect
weld seams

Limit switch for
automatic stop-
ping or changing
direction

ARCROVER 22

THE PERFORMANCE CARRIAGE

YOUR BENEFITS AT A GLANCE

- / Ideal for use under tough environmental conditions
- / Meets safety rules for welding the inside of containers
- / Powerful lithium-ion battery
- / Maximum traction on horizontal, vertical, concave and convex components
- / Constant welding speed in all positions up to 200 cm/min
- / Precise welding torch guidance on the component, oscillation, definable welding segments
- / Consistently high welding seam quality and reproducible welding parameters combined with Fronius power source technology
- / Compact, robust and lightweight aluminium housing
- / Global service network

FEATURES

- / Four-wheel drive, built-in permanent magnet
- / Integrated control system with illuminated display and travel-measuring system
- / Adjustable lateral guides
- / Robust universal welding torch holder for hand and machine welding torch
- / Limit switch for automatic stopping or changing direction
- / Connection cable to power source (10 m)
- / Changeable lithium-ion battery (25.4 V/3.35 Ah) and charging unit (230 V)

FUNCTIONS

Carriage:

- / Main switch: on/off
- / Left/stop/right
- / Speed control
- / Digital speedometer
- / On/Off welding (2-step mode)
- / Menu-based control system for travel paths, segment welding, end-crater filling and OSC
- / Storage for 10 programs

Oscillation unit:

- / OSC on/off/automatic
- / Dwell time left/right
- / Oscillation speed
- / Oscillation path

OPTIONS AND ACCESSORIES

- / Lateral guides
- / FOU 30 / ML6 radial welding torch oscillation unit
- / Motorised torch adjustment with FMS 50/100
- / Charging unit (230 V)
- / Changeable lithium-ion battery (25.4 V/3.35 Ah)
- / Stainless steel wheels
- / Brushes



Constant
welding speed
in all positions

ARCROVER 22. FOR LARGE WELD VOLUMES AND HIGH A-DIMENSIONS.



STANDARD EQUIPMENT

A	Control unit ON/OFF toggle switch	I	Limit switch (limit position detection)
B	Connection for power source control	J	Adjusting dial menu
C	Connection for FMS 50/100 motor slide	K	Illuminated display
D	Connection for FOU 30/ML6 oscillation unit	L	Motor slide adjusting dial (FMS-Offset)
E	Welding toggle switch I/O/TEST	M	Removable rechargeable battery pack
F	Toggle switch Start LEFT/0/RIGHT	N	Handle
G	Welding speed adjusting dial	O	Hosepack holder
H	Adjustable guide rails	P	Universal welding torch holder

STANDARD lateral GUIDES FOR ARCROVER 22 (IN SCOPE OF DELIVERY)



LATERAL GUIDE **ON TORCH SIDE**

On inside and outside of vertical surface

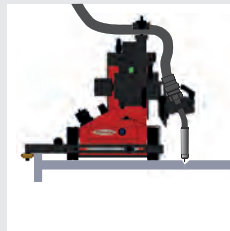

LATERAL GUIDE **OPPOSITE TO WELDING TORCH**

On the elbow piece and outside vertical surface



OPTIONAL LATERAL GUIDES FOR ARCROVER 22



LATERAL GUIDE **TILTABLE**



LATERAL GUIDE **FOR EDGE**



LATERAL GUIDE **STANDARD WITH MAGNET**



LATERAL GUIDE **WITH GUIDE RAIL**

- / Guide arm for flexible rail
- / Magnetic bases for guide rail
- / Flexible guide rail



OPTIONS/ACCESSORIES

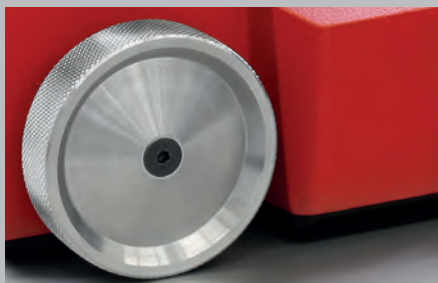

Stainless steel wheels

/ Optional. For use on preheated components from 50°C to 150°C max. It is only possible to use the carriage in the horizontal position with stainless steel wheels.



Brushes

/ Optional (assembly sketch). Ensure that the carriage can move smoothly by removing any surface dirt.



LITHIUM-ION BATTERY / CHARGER

/ High-performance 25.4 V DC lithium-ion batterie with charging unit. Minimum operating time with normal usage and no oscillation = 4 h.



FOU 30/ML6 radial oscillation unit

/ Optional. Oscillation unit for butt and fillet welds.



TORCH DELIVERY FMS 50/100

/ Optional. Motorized vertical torch adjustment.

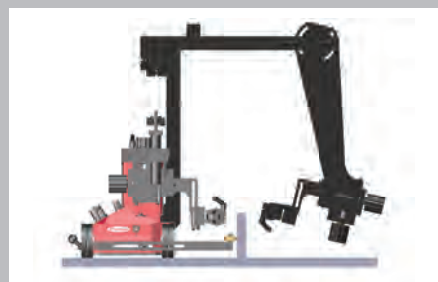

SECOND WELDING TORCH HOLDER

/ Optional. For use with two welding torches (operation is only possible in horizontal position).

APPLICATION EXAMPLES



/ Welding butt welds on horizontal components



/ Welding fillet welds on horizontal components



/ Welding butt welds on vertical components



/ Welding fillet welds on convex components



/ Welding butt welds on concave components

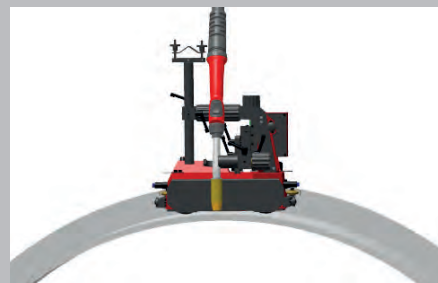

/ Welding butt welds on convex components

TECHNICAL DATA

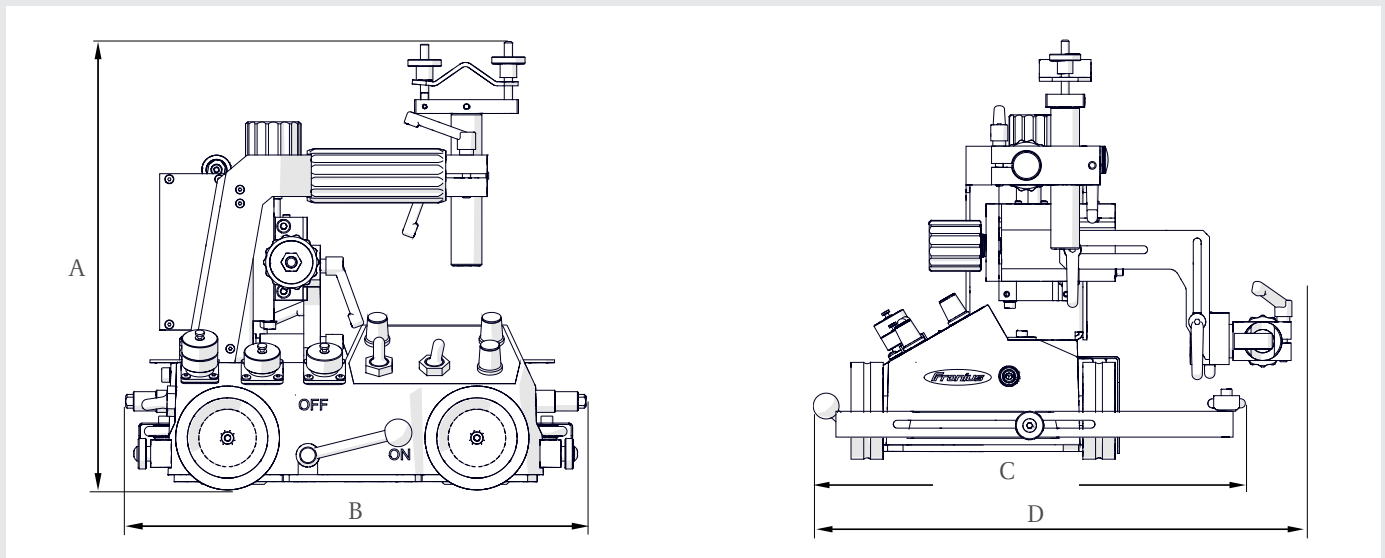

ARCROVER 22

Maximum load capacity	22 kg
Max. traction horizontal/vertical (on hosepack holder)	230 N / 110 N
Welding position horizontal/vertical	PA, PB, PC/PE, PG
Horizontal speed (load = 85 N)	5 - 200 cm/min (+/- 6%)
Vertical speed (load = 85 N)	5 - 200 cm/min (+/- 6%)
Adjustable torch travel (horizontal/vertical)	30 mm/30 mm
Welding torch neck diameter	Max. 28 mm
Battery charging unit supply voltage (50 - 60 Hz)	110 - 230 V
Carriage supply voltage (lithium ion battery)	25.4 V DC
Energy consumption	49 W
Lithium-ion battery charging time	2 h
Unladen weight including lithium-ion battery	10.7 kg
Concave seam R min.	500 mm
Convex seam R min.	1500 mm
Ground clearance	6 mm
Minimum operating time for each lithium-ion battery with normal usage and without OSC	4 h
Minimum operating time for each lithium-ion battery with normal usage and OSC	2 h
A	294 - 374 mm
B	332 mm
C	287 - 437 mm
D	315 - 400 mm

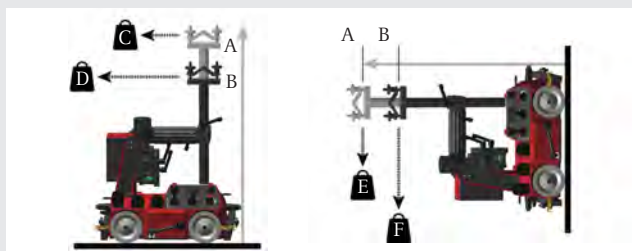

MAX. TENSILE LOAD ON THE HOSEPACK HOLDER

A	50 mm
B	80 mm
C	15 kg
D	12 kg
E	10 kg
F	8 kg

WE HAVE THREE DIVISIONS AND ONE PASSION: SHIFTING THE LIMITS OF POSSIBILITY.

/ What Günter Fronius started in 1945 in Pettenbach, Austria, has now become a modern day success story. Today, the company has around 3,800 employees worldwide and has been granted more than 1,200 patents. Our goal has remained constant throughout: to be the innovation leader. We shift the limits of what's possible. While others progress step by step, we innovate in leaps and bounds. The responsible use of our resources forms the basis of our corporate policy.

PERFECT WELDING

/ We develop products and complete systems - both manual and automated - as well as the corresponding services for our customers in the global welding technology market. We have made it our goal to decode the "DNA of the arc".

SOLAR ENERGY

/ The challenge is to make the leap to a regenerative energy supply. Our vision is to use renewable energy to achieve energy independence. With our services, inverters and energy-storage systems for optimising energy yields, we are one of the leading suppliers in the photovoltaics sector.

PERFECT CHARGING

/ As know-how leaders in the world of battery charging, we deliver exceptional solutions to create the maximum benefit for our customers. For the intralogistics sector, we are committed to energy flow optimisation for electric forklift trucks and are constantly striving for the next innovation. Our powerful charging systems for vehicle workshops guarantee safe and reliable processes.

Further information about all Fronius products and our global sales partners and representatives can be found at www.fronius.com

Fronius India Private Limited
GAT no 312, Nanekarwadi
Chakan, Taluka - Khed District
Pune 410501
India
Telephone + 91 98 20 60 52 07
sales.india@fronius.com
www.fronius.in

Fronius (Thailand) Ltd.
Pinthong Industrial Estate I
789/193 Moo 1, Sriracha,
Chonburi 20230
Building: P17/B1
Thailand
sales.Thailand@fronius.com
www.fronius.co.th

Fronius Middle East FZE
P.O. Box: 263241
Jebel Ali / JAFZA ONE BUILDING
Dubai / U.A.E
Telephone +971 (0) 56 499 8224
contact.middleeast@fronius.com
www.fronius.ae/pw

Fronius Canada Ltd.
2875 Argentia Road, Units 4,5 & 6
Mississauga, ON L5N 8G6
Canada
Telephone +1 905 288-2100
Fax +1 905 288-2101
sales.canada@fronius.com
www.fronius.ca

Fronius USA LLC
6797 Fronius Drive
Portage, IN 46368
USA
Telephone +1 877 FRONIUS
sales.usa@fronius.com
www.fronius-usa.com

Fronius UK Limited
Maidstone Road, Kingston
Milton Keynes, MK10 0BD
United Kingdom
Telephone +44 1908 512 300
Fax +44 1908 512 329
info-uk@fronius.com
www.fronius.co.uk

Fronius International GmbH
Froniusplatz 1
4600 Wels
Austria
Telephone +43 7242 241-0
Fax +43 7242 241-953940
sales@fronius.com
www.fronius.com